



Member of the FM Global Group

FM Approvals  
 1151 Boston Providence Turnpike  
 P.O. Box 9102 Norwood, MA 02062 USA  
 T: 781 762 4300 F: 781-762-9375 www.fmapprovals.com

# CERTIFICATE OF COMPLIANCE

## HAZARDOUS (CLASSIFIED) LOCATION ELECTRICAL EQUIPMENT

This certificate is issued for the following equipment:

### **BA484Da Serial Text Display**

IS / I / 1, II, III / ABCDEFG / T4 Ta = 60°C – CI480-07; Entity; Type 4X, IP66  
 I / 0 / AEx ia IIC T4 Ta = 60°C – CI480-07; Entity; Type 4X, IP66  
 NI / I / 2 / ABCD / T4 Ta = 60°C – CI480-08; NIFW; Type 4X, IP66  
 S / II / 2 / EFG / T4 Ta = 60°C – SCI-1011; NIFW; Type 4X, IP66  
 S / III / 2 / T4 Ta = 60°C – SCI-1011; NIFW; Type 4X, IP66  
 I / 2 / IIC / T4 Ta = 60°C – CI480-08; NIFW; Type 4X, IP66

### Intrinsic Safety Parameters

#### Input Parameters

Terminals	Ui (V)	Ii (mA)	Pi (W)	Ci (µF)	Li (mH)
1 & 2	25	108	0.58	0.01	0.02
4 & 2	14	108	0.45	0	0
1, 2, 5 & 6	20	139	0.46	0.01	0.02
S1 to S7	0	0	0	0.54	0.3
A1 & A2; A3 & A4	28	200	0.85	0.04	0.02

#### Output Parameters

Terminals	Uo (V)	Io (mA)	Po (W)	Co (µF)	Lo (mH)
S1 to S7	14.7	146.7	0.58	0.08	1.1
A1 & A2; A3 & A4	1.49	0.0001	0.003	1000	1000

### Nonincendive Field Wiring Parameters

#### Input Parameters

Terminals	Ui (V)	Ii (mA)	Pi (W)	Ci (µF)	Li (mH)
1 & 2	25	-	-	0.01	0.02
4 & 2	14	-	-	0	0
1, 2, 5 & 6	20	-	-	0.01	0.02
A1 & A2; A3 & A4	32	-	-	0.04	0.02



Member of the FM Global Group

**Output Parameters**

Terminals	Uo (V)	Io (mA)	Po (W)	Co (μF)	Lo (mH)
S1 to S7	14.7	146.7	-	0.08	1.1

a = Parameter not affecting safety.

*Special conditions of use*

1. The BA484D shall be protected from direct exposure to sunlight.

**BA488Ca Serial Text Display**

IS / I / 1 / ABCD / T4 Ta = 60°C – CI480-07; Entity; Type 4X\*, IP66\*

I / 0 / AEx ia IIC T4 Ta = 60°C – CI480-07; Entity; Type 4X\*, IP66\*

NI / I / 2 / ABCD / T4 Ta = 60°C – CI480-08; NIFW; Type 4X\*, IP66\*

I / 2 / IIC / T4 Ta = 60°C – CI480-08; NIFW; Type 4X\*, IP66\*

\* Front panel only.

**Intrinsic Safety Parameters**

**Input Parameters**

Terminals	Ui (V)	Ii (mA)	Pi (W)	Ci (μF)	Li (mH)
1 & 2	25	108	0.58	0.01	0.02
4 & 2	14	108	0.45	0	0
1, 2, 5 & 6	20	139	0.46	0.01	0.02
S1 to S7	0	0	0	0.54	0.3
A1 & A2; A3 & A4	28	200	0.85	0.04	0.02

**Output Parameters**

Terminals	Uo (V)	Io (mA)	Po (W)	Co (μF)	Lo (mH)
S1 to S7	14.7	146.7	0.58	0.08	1.1
A1 & A2; A3 & A4	1.49	0.0001	0.003	1000	1000

**Nonincendive Field Wiring Parameters**

**Input Parameters**

Terminals	Ui (V)	Ii (mA)	Pi (W)	Ci (μF)	Li (mH)
1 & 2	25	-	-	0.01	0.02
4 & 2	14	-	-	0	0
1, 2, 5 & 6	20	-	-	0.01	0.02
A1 & A2; A3 & A4	32	-	-	0.04	0.02

**Output Parameters**

Terminals	Uo (V)	Io (mA)	Po (W)	Co (μF)	Lo (mH)
S1 to S7	14.7	146.7	-	0.08	1.1

a = Parameter not affecting safety.

*Special conditions of use*

1. To maintain the Type 4X enclosure rating the BA488C shall be installed in accordance with the



Member of the FM Global Group

mounting conditions provided on drawing numbers CI480-07 and CI480-08.

2. The BA488C shall be installed in compliance with the enclosure, mounting, spacing and segregation requirements of the ultimate application.
3. The BA488C shall be protected from direct exposure to sunlight.

## Equipment Ratings:

### **BA484Da Serial Text Display**

Intrinsically Safe for Class I, II and III, Division 1, Groups A, B, C, D, E, F and G; and Class I, Zone 0, Group IIC Hazardous (Classified) Locations using the Entity Concept when installed in accordance with Control Drawing CI480-07.

Nonincendive for Class I, Division 2, Groups A, B, C and D and Class I, Zone 2, Group IIC Hazardous (Classified) Locations using the Nonincendive Field Wiring Concept when installed in accordance with Control Drawing CI480-08.

Suitable for Class II, Division 2, Groups E, F and G Hazardous (Classified) Locations using the Nonincendive Field Wiring Concept when installed in accordance with Control Drawing CI480-08.

Suitable for Class III, Division 2, Hazardous (Classified) Locations using the Nonincendive Field Wiring Concept when installed in accordance with Control Drawing CI480-08.

### **BA488Ca Serial Text Display**

Intrinsically Safe for Class I, Division 1, Groups A, B, C, and D; and Class I, Zone 0, Group IIC Hazardous (Classified) Locations using the Entity Concept when installed in accordance with Control Drawing CI480-07

Nonincendive for Class I, Division 2, Groups A, B, C and D and Class I, Zone 2, Group IIC Hazardous (Classified) Locations using the Nonincendive Field Wiring Concept when installed in accordance with Control Drawing CI480-08.

## FM Approved for:

BEKA associates  
Hitchin, Hertfordshire SG5 2DA, United Kingdom



Member of the FM Global Group

This certifies that the equipment described has been found to comply with the following Approval Standards and other documents:

Class 3600	1998
Class 3610	2010
Class 3611	2004
Class 3810	2005
NEMA 250	1991

Original Project ID: 3025514

Approval Granted: May 3, 2006

Subsequent Revision Reports / Date Approval Amended

Report Number	Date	Report Number	Date
101217	March 16, 2011		

FM Approvals LLC

Timothy J. Adam  
Technical Team Manager

March 16, 2011  
Date



Member of the FM Global Group

FM Approvals  
 1151 Boston-Providence Turnpike  
 P.O. Box 9102 Norwood, MA 02062 USA  
 T: 781 762 4300 F: 781 762 9375 www.fmglobal.com

# CERTIFICATE OF COMPLIANCE

## HAZARDOUS (CLASSIFIED) LOCATION ELECTRICAL EQUIPMENT

This certificate is issued for the following equipment:

### **BA484Da Serial Text Display**

IS / I / 1, II, III / ABCDEFG / T4 Ta = 60°C – CI480-07; Entity; Type 4X, IP66

I / 0 / AEx ia IIC T4 Ta = 60°C – CI480-07; Entity; Type 4X, IP66

NI / I / 2 / ABCD / T4 Ta = 60°C – CI480-08; NIFW; Type 4X, IP66

S / II / 2 / EFG / T4 Ta = 60°C – SCI-1011; NIFW; Type 4X, IP66

S / III / 2 / T4 Ta = 60°C – SCI-1011; NIFW; Type 4X, IP66

I / 2 / IIC / T4 Ta = 60°C – CI480-08; NIFW; Type 4X, IP66

### Intrinsic Safety Parameters

#### Input Parameters

Terminals	Ui (V)	Ii (mA)	Pi (W)	Ci (µF)	Li (mH)
1 & 2	25	108	0.58	0.01	0.02
4 & 2	14	108	0.45	0	0
1, 2, 5 & 6	20	139	0.46	0.01	0.02
S1 to S7	0	0	0	0.54	0.3
A1 & A2; A3 & A4	28	200	0.85	0.04	0.02

#### Output Parameters

Terminals	Uo (V)	Io (mA)	Po (W)	Co (µF)	Lo (mH)
S1 to S7	14.7	146.7	0.58	0.08	1.1
A1 & A2; A3 & A4	1.49	0.0001	0.003	1000	1000

### Nonincendive Field Wiring Parameters

#### Input Parameters

Terminals	Ui (V)	Ii (mA)	Pi (W)	Ci (µF)	Li (mH)
1 & 2	25	-	-	0.01	0.02
4 & 2	14	-	-	0	0
1, 2, 5 & 6	20	-	-	0.01	0.02
A1 & A2; A3 & A4	32	-	-	0.04	0.02

**Output Parameters**

Terminals	Uo (V)	Io (mA)	Po (W)	Co (μF)	Lo (mH)
S1 to S7	14.7	146.7	-	0.08	1.1

a = Parameter not affecting safety.

*Special conditions of use*

1. The BA484D shall be protected from direct exposure to sunlight.

**BA488Ca Serial Text Display**

IS / I / 1 / ABCD / T4 Ta = 60°C – CI480-07; Entity; Type 4X\*, IP66\*

I / 0 / AEx ia IIC T4 Ta = 60°C – CI480-07; Entity; Type 4X\*, IP66\*

NI / I / 2 / ABCD / T4 Ta = 60°C – CI480-08; NIFW; Type 4X\*, IP66\*

I / 2 / IIC / T4 Ta = 60°C – CI480-08; NIFW; Type 4X\*, IP66\*

\* Front panel only.

**Intrinsic Safety Parameters**

**Input Parameters**

Terminals	Ui (V)	Ii (mA)	Pi (W)	Ci (μF)	Li (mH)
1 & 2	25	108	0.58	0.01	0.02
4 & 2	14	108	0.45	0	0
1, 2, 5 & 6	20	139	0.46	0.01	0.02
S1 to S7	0	0	0	0.54	0.3
A1 & A2; A3 & A4	28	200	0.85	0.04	0.02

**Output Parameters**

Terminals	Uo (V)	Io (mA)	Po (W)	Co (μF)	Lo (mH)
S1 to S7	14.7	146.7	0.58	0.08	1.1
A1 & A2; A3 & A4	1.49	0.0001	0.003	1000	1000

**Nonincendive Field Wiring Parameters**

**Input Parameters**

Terminals	Ui (V)	Ii (mA)	Pi (W)	Ci (μF)	Li (mH)
1 & 2	25	-	-	0.01	0.02
4 & 2	14	-	-	0	0
1, 2, 5 & 6	20	-	-	0.01	0.02
A1 & A2; A3 & A4	32	-	-	0.04	0.02

**Output Parameters**

Terminals	Uo (V)	Io (mA)	Po (W)	Co (μF)	Lo (mH)
S1 to S7	14.7	146.7	-	0.08	1.1

a = Parameter not affecting safety.

*Special conditions of use*

1. To maintain the Type 4X enclosure rating the BA488C shall be installed in accordance with the mounting conditions provided on drawing numbers CI480-07 and CI480-08.
2. The BA488C shall be installed in compliance with the enclosure, mounting, spacing and segregation requirements of the ultimate application.
3. The BA488C shall be protected from direct exposure to sunlight.

Equipment Ratings:

**BA484Da Serial Text Display**

Intrinsically Safe for Class I, II and III, Division 1, Groups A, B, C, D, E, F and G; and Class I, Zone 0, Group IIC Hazardous (Classified) Locations using the Entity Concept when installed in accordance with Control Drawing CI480-07.

Nonincendive for Class I, Division 2, Groups A, B, C and D and Class I, Zone 2, Group IIC Hazardous (Classified) Locations using the Nonincendive Field Wiring Concept when installed in accordance with Control Drawing CI480-08.

Suitable for Class II, Division 2, Groups E, F and G Hazardous (Classified) Locations using the Nonincendive Field Wiring Concept when installed in accordance with Control Drawing CI480-08.

Suitable for Class III, Division 2, Hazardous (Classified) Locations using the Nonincendive Field Wiring Concept when installed in accordance with Control Drawing CI480-08.

**BA488Ca Serial Text Display**

Intrinsically Safe for Class I, Division 1, Groups A, B, C, and D; and Class I, Zone 0, Group IIC Hazardous (Classified) Locations using the Entity Concept when installed in accordance with Control Drawing CI480-07

Nonincendive for Class I, Division 2, Groups A, B, C and D and Class I, Zone 2, Group IIC Hazardous (Classified) Locations using the Nonincendive Field Wiring Concept when installed in accordance with Control Drawing CI480-08.

FM Approved for:

BEKA Associates  
Hitchin, Hertfordshire SG5 2DA United Kingdom

This certifies that the equipment described has been found to comply with the following Approval Standards and other documents:

Class 3600	1998
Class 3610	1999
Class 3611	2004
Class 3810	2006
NEMA 250	1991

Original Project ID: 3025514

Approval Granted: May 3, 2006

Subsequent Revision Reports / Date Approval Amended

Report Number	Date	Report Number	Date
060530	12/29/06		

FM Approvals LLC



George A. Smith  
Assistant Vice President

12/29/06  
Date



Iss.	1	03/05	Modification	First release	Appd.	
Iss.	2	01/08	Modification	CFM requirements added.	Appd.	
Iss.			Date		Modification	
Iss.			Ckd.			

**BEKA associates**  
 Hitchin  
 England  
 company confidential, copyright reserved.

**HAZARDOUS (CLASSIFIED) LOCATION**

**BA484D LOCATIONS:**  
 Class I, Division 1, Groups A, B, C, D  
 Class II, Division 1, Groups E, F & G  
 Class III  
 Class I, Zone 0, Group IIC

**BA488C LOCATIONS:**  
 Class I, Division 1, Groups A, B, C, D  
 Class I, Zone 0, Group IIC

**BA484D and BA488C Entity Parameters**

Terminals 1 & 2  
 $U_i = 25V$  dc  
 $I_i = 108mA$   
 $P_i = 0.58W$   
 $C_i = 0.01\mu F$   
 $L_i = 0.02mH$

Terminals S1 to S7 (combined parameters)  
 $U_i = 0$                        $U_o = 14.7V$  dc  
 $I_i = 0$                          $I_o = 146.7mA$  dc  
 $P_i = 0$                          $P_o = 0.58W$   
 $C_i = 0.54\mu F$                $C_o = 0.08\mu F$   
 $L_i = 0.3mH$                  $L_o = 1.1mH$

Terminals A1 & A2; A3 & A4;  
 $U_i = 28V$  dc                 $U_o = 1.49V$  dc  
 $I_i = 200mA$  dc             $I_o = 1\mu A$  dc  
 $P_i = 0.85W$                  $P_o = 3\mu W$   
 $C_i = 0.04\mu F$              $C_o = 1000\mu F$   
 $L_i = 0.02mH$              $L_o = 1000mH$

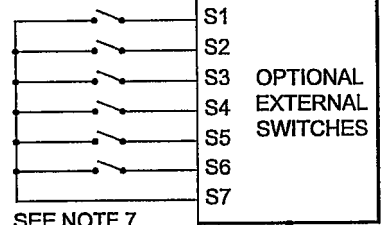

**Two Wire System**

SEE NOTE 11

**UNCLASSIFIED LOCATION**

**SUB-MASTER**

SEE NOTE 1

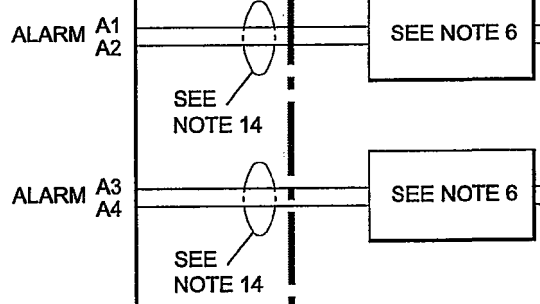
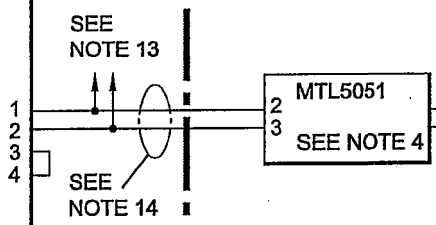
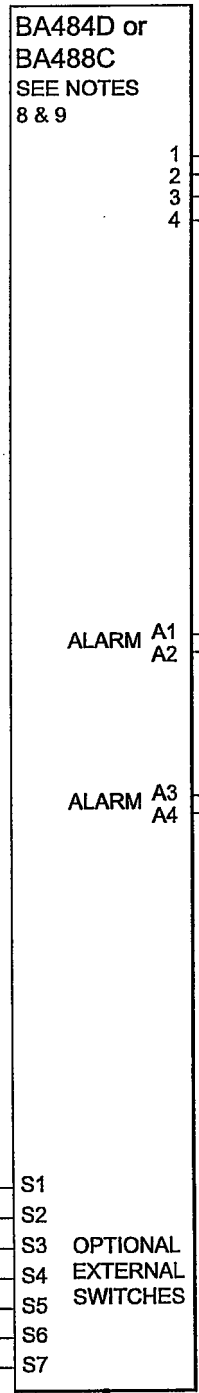

\*\*\*\*\*  
 Note:  
 No modification to be made without reference/approval from FM Approvals and BEKA Associates Design Department.  
 \*\*\*\*\*

Date	03/05	Drawn	RC	Checked		Scale	NTS
Iss.	1	Title		Drawing No.		Sheet 1 of 5	
Iss.	2	FM Approvals Control Drawing for Intrinsically Safe BA484D & BA488C Serial Text Displays		CI480-07			

Iss.	1	Date	03/05/2006	Modification	First release	Ckd.		Appd.	
Iss.	2	Date	01/08	Modification	CFM requirements added.	Ckd.		Appd.	

**BEKA associates**  
Hitchin England  
company confidential, copyright reserved.

**HAZARDOUS (CLASSIFIED) LOCATION**

**BA484D LOCATIONS:**  
Class I, Division 1, Groups A, B, C, D  
Class II, Division 1, Groups E, F & G  
Class III  
Class I, Zone 0, Group IIC

**BA488C LOCATIONS:**  
Class I, Division 1, Groups A, B, C, D  
Class I, Zone 0, Group IIC

**BA484D and BA488C Entity Parameters**

**Terminals 1 & 2**  
 $U_i = 25V$  dc  
 $I_i = 108mA$   
 $P_i = 0.58W$   
 $C_i = 0.01\mu F$   
 $L_i = 0.02mH$

**Terminals 4 & 2**  
 $U_i = 14V$  dc  
 $I_i = 108mA$   
 $P_i = 0.45W$   
 $C_i = 0$   
 $L_i = 0$

**Terminals S1 to S7 (combined parameters)**  
 $U_i = 0$        $U_o = 14.7V$  dc  
 $I_i = 0$        $I_o = 146.7mA$  dc  
 $P_i = 0$        $P_o = 0.58W$   
 $C_i = 0.54\mu F$        $C_o = 0.08\mu F$   
 $L_i = 0.3mH$        $L_o = 1.1mH$

**Terminals A1 & A2; A3 & A4;**  
 $U_i = 28V$  dc       $U_o = 1.49V$  dc  
 $I_i = 200mA$  dc       $I_o = 1\mu A$  dc  
 $P_i = 0.85W$        $P_o = 3\mu W$   
 $C_i = 0.04\mu F$        $C_o = 1000\mu F$   
 $L_i = 0.02mH$        $L_o = 1000mH$

**UNCLASSIFIED LOCATION**

**SUB-MASTER**

SEE NOTE 1

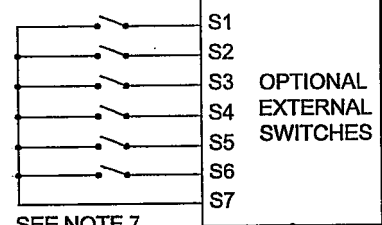
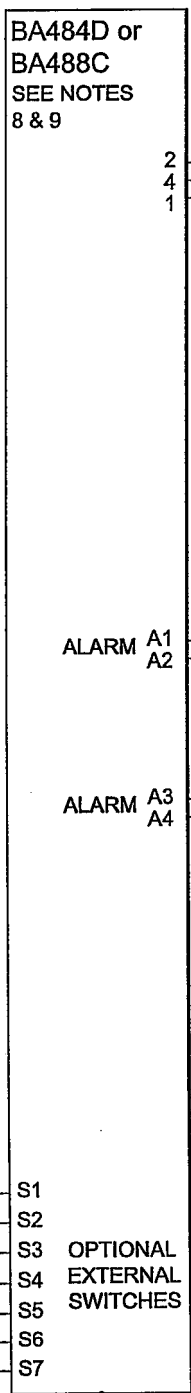

**Three Wire System**

SEE NOTE 11

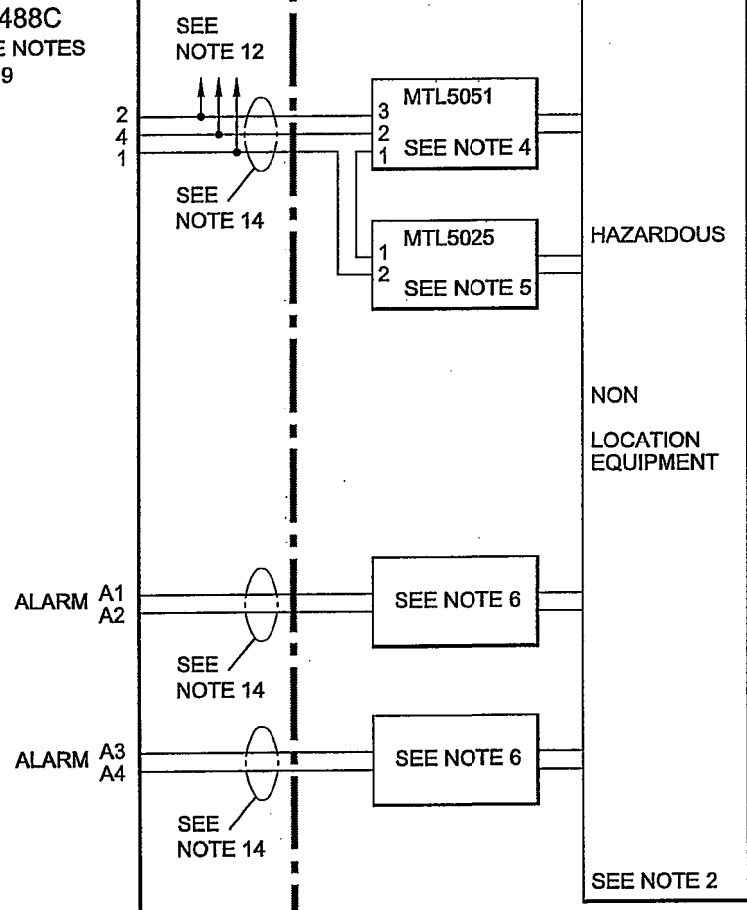

Title  
FM Approvals Control Drawing for  
Intrinsically Safe BA484D & BA488C Serial Text Displays

Drawn	RC	Checked	Scale
			NTS
Drawing No. Sheet 2		C1480-07	



# SUB-MASTER

Notes:

1. The associated intrinsically safe barriers must be FM approved and the manufacturers' installation drawings shall be followed when installing this equipment.  
For installations in Canada the associated intrinsically safe barriers and galvanic isolators must be CFM or CSA approved and the manufacturers' installation drawings shall be followed when installing the equipment.
2. The unclassified location equipment connected to the associated intrinsically safe barriers or galvanic isolators shall not use or generate more than 250V rms or 250V dc.
3. Installation shall be in accordance with ANSI/ISA RP 12.06.01 "Installation of Intrinsically Safe Systems for Hazardous (Classified) Locations" and the National Electrical Code ANSI/NFPA 70. Installations in Canada shall be in accordance with the Canadian Electrical Code C22.2
4. MTL5051 Serial-Data Communications Isolator FM File J.I. 3000682 CSA certificate 1000852
5. MTL5025 Solenoid / Alarm Driver FM File J.I. 3Z9A8.AX CSA certificate 1547041
6. One single channel or one channel of a dual channel associated intrinsically safe barrier or galvanic isolator with entity parameters complying with the following requirements:

Vo or Vt	equal to or less than	Vi
Io or It	equal to or less than	Ii
La	equal to or greater than	Lcable + Li
Ca	equal to or greater than	Ccable + Ci

7. Hazardous (classified) location equipment may be simple apparatus e.g. mechanically activated switches or FM, CFM or CSA Approved equipment with entity parameters complying with following requirements:

Vo or Vt	equal to or less than	Vi
Io or It	equal to or less than	Ii
La	equal to or greater than	Lcable + Li
Ca	equal to or greater than	Ccable + Ci

8. To maintain IP66 protection between the BA488C and the mounting panel:

Four panel mounting clips should be used

Minimum panel thickness should be 2mm (0.08inches) Steel  
3mm (0.12inches) Aluminium

Outside panel finish should be smooth, free from particle inclusions, runs or build-up around cut-out.

Panel cut-out should be 66.2 x 136.0mm -0.0 +0.5  
(2.60 x 5.35 inches -0.00 +0.02)

Edges of panel cut-out should be deburred and clean

Each panel mounting clip should be tightened to between: 20 and 22cNm  
(1.77 to 1.95 inLb)

Iss.	Date	Modification	Ckd.	Appd.
1	03.05 2006	First release		
2	01/08	CFM requirements added.		

**BEKA associates**  
Hitchin England  
company confidential, copyright reserved.

Title	Drawn	Checked	Scale
FM Approvals Control Drawing for Intrinsically Safe BA484D & BA488C Serial Text Displays	RC		NTS
	Drawing No. Sheet 4		CI480-07

# SUB - MASTER

9. When installed in a hazardous (classified) location the BA484D Serial Text Display shall be fitted with cable glands / conduit hubs selected from the following table

Metallic glands and hubs must be grounded - see note 10.

Class	Permitted gland or conduit hub
Class I	Any metallic or plastic cable gland or conduit hub that provides the required environmental protection.
Class II and III	<p><b>Crouse - Hinds Myler hubs</b>            ST-1    STA-1    SSTG-1    STG-1    STAG-1            MHUB-1    HUB 1</p> <p><b>O-Z / Gedrey Hubs</b>            CHM-50DT    CHMG-50DT</p> <p><b>Killark Glands</b>            CMCXAA050    MCR050    MCX050</p>

10. In addition to the supplied bonding plate, when metallic 2 or 3 glands or conduit hubs are fitted to a BA484D Serial Text Display, all metallic glands or conduit hubs must be connected together and grounded.

11. **WARNING:** The BA484D and BA488C Serial Text Display are manufactured from conductive plastic per Article 250 of the National Electrical Code the enclosures shall be grounded using the 'E' terminal on the terminal block.

12. Up to four BA484D and/or BA488C Serial Text Displays may be connected to one system.

13. Up to two BA484D and/or BA488C Serial Text Displays may be connected to one system.

14. Separate intrinsically safe circuit wiring shall comply with either:

a. All conductors of each circuit shall be within a grounded metal shield.

b. The conductors of each intrinsically safe circuit shall have insulation with a minimum thickness of 0.25mm (0.01in).

**BEKA associates**  
 Hitchin England  
 company confidential, copyright reserved.

Iss.		Date		Iss.		Date		Modification		Ckd.		Appd.	
1		03.05 2006						First release					
2		01/08						CFM requirements added.					

Title FM Approvals Control Drawing for Intrinsically Safe BA484D & BA488C Serial Text Displays	Drawn RC	Checked	Scale NTS
Drawing No. Sheet 5		<h2 style="margin: 0;">CI480-07</h2>	



# SUB-MASTER

## HAZARDOUS (CLASSIFIED) LOCATION

## UNCLASSIFIED LOCATION

**BA484D LOCATIONS:**  
 Class I, Division 2, Groups A, B, C, D  
 Class II, Division 2, Groups E, F & G  
 Class III  
 Class I, Zone 2, Group IIC

**BA488C LOCATIONS:**  
 Class I, Division 2, Groups A, B, C, D  
 Class I, Zone 2, Group IIC

**BA484D and BA488C**  
**Maximum input and output Parameters**

Terminals 1 & 2  
 $V_{max} = 25V$  dc  
 $C_i = 0.01\mu F$   
 $L_i = 0.02mH$

Terminals S1 to S7  
 (combined parameters)  
 $V_{max} = 0$        $V_{oc} = 14.7Vdc$   
 $I_{sc} = 146.7mA_{dc}$   
 $C_o = 0.08\mu F$   
 $L_o = 1.1mH$

Terminals A1 & A2; A3 & A4;  
 $V_{max} = 32V$  dc  
 $C_i = 0.04\mu F$   
 $L_i = 0.02mH$

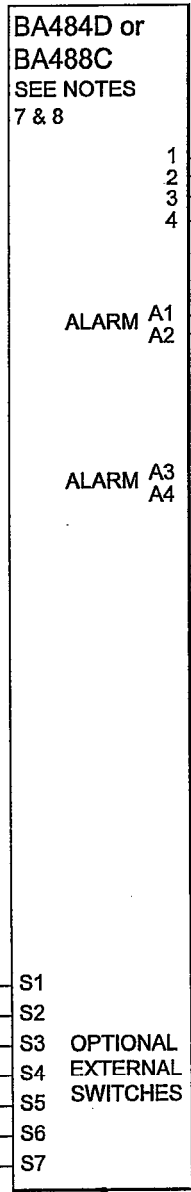

SEE NOTE 2

SEE NOTE 11

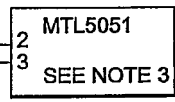

1  
2  
3  
4

SEE NOTE 5

ALARM A1  
A2

SEE NOTE 5

ALARM A3  
A4

NON HAZARDOUS LOCATION EQUIPMENT

SEE NOTE 1

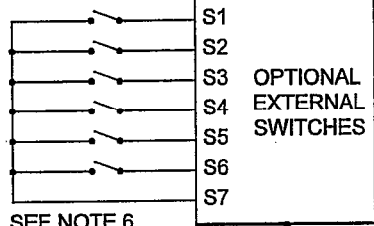

SEE NOTE 6

SEE NOTE 10

## Two Wire System

\*\*\*\*\*  
 Note:  
 No modification to be made  
 without reference/approval  
 from FM Approvals and  
 BEKA Associates Design  
 Department.  
 \*\*\*\*\*

Iss.	Date	Modification	Ckd.	Appd.
1	01/03/2006	First release		
2	01/08	CFM requirements added.		

Title  
 FM Approvals Control Drawing for  
 Nonincendive BA484D & BA488C Serial Text Displays

Drawn RC	Checked	Scale NTS
Drawing No. Sheet 1 of 5		CI480-08



# SUB-MASTER

## HAZARDOUS (CLASSIFIED) LOCATION

## UNCLASSIFIED LOCATION

### BA484D LOCATIONS:

Class I, Division 2, Groups A, B, C, D  
 Class II, Division 2, Groups E, F & G  
 Class III  
 Class I, Zone 2, Group IIC

### BA488C LOCATIONS:

Class I, Division 2, Groups A, B, C, D  
 Class I, Zone 2, Group IIC

### BA484D and BA488C Maximum input and output Parameters

Terminals 1 & 2  
 $V_{max} = 25V$  dc  
 $C_i = 0.01\mu F$   
 $L_i = 0.02mH$

Terminals 4 & 2  
 $V_{max} = 14V$  dc  
 $C_i = 0$   
 $L_i = 0$

Terminals S1 to S7  
 (combined parameters)  
 $V_{max} = 0$        $V_{oc} = 14.7V_{dc}$   
 $I_{sc} = 146.7mA_{dc}$   
 $C_o = 0.08\mu F$   
 $L_o = 1.1mH$

Terminals A1 & A2; A3 & A4;  
 $V_{max} = 32V$  dc  
 $C_i = 0.04\mu F$   
 $L_i = 0.02mH$

BA484D or  
 BA488C  
 SEE NOTES  
 7 & 8

SEE  
 NOTE 12

SEE  
 NOTE 2

MTL5051  
 3  
 2  
 1  
 SEE NOTE 3

MTL5025  
 1  
 2  
 SEE NOTE 4

ALARM A1  
 A2

SEE NOTE 5

ALARM A3  
 A4

SEE NOTE 5

NON-  
 HAZARDOUS  
 LOCATION  
 EQUIPMENT

SEE NOTE 1

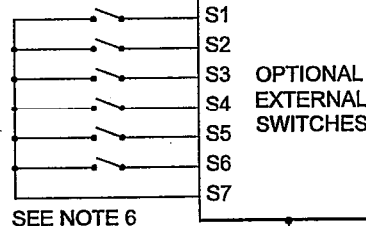

SEE NOTE 6

SEE NOTE 10

## Three Wire System

Iss.	Date	Modification	Ckd.	Appd.
1	01/03 2006	First release		
2	01/08	CFM requirements added.		

**BEKA associates**  
 Hitchin  
 England  
 company confidential, copyright reserved.

Title  
 FM Approvals Control Drawing for  
 Nonincendive BA484D & BA488C Serial Text Displays

Drawn RC	Checked	Scale NTS
Drawing No. Sheet 2		CI480-08



# SUB-MASTER

## HAZARDOUS (CLASSIFIED) LOCATION

## UNCLASSIFIED LOCATION

### BA484D LOCATIONS:

Class I, Division 2, Groups A, B, C, D  
 Class II, Division 2, Groups E, F & G  
 Class III  
 Class I, Zone 2, Group IIC

### BA488C LOCATIONS:

Class I, Division 2, Groups A, B, C, D  
 Class I, Zone 2, Group IIC

SEE  
 NOTE 2

### BA484D and BA488C Maximum input and output Parameters

Terminals 1, 2, 5 & 6  
 $V_{max} = 20V$  dc  
 $C_i = 0.01\mu F$   
 $L_i = 0.02mH$

Terminals S1 to S7  
 (combined parameters)  
 $V_{max} = 0$      $V_{oc} = 14.7Vdc$   
 $I_{sc} = 146.7mA_{dc}$   
 $C_o = 0.08\mu F$   
 $L_o = 1.1mH$

Terminals A1 & A2; A3 & A4;  
 $V_{max} = 32V$  dc  
 $C_i = 0.04\mu F$   
 $L_i = 0.02mH$

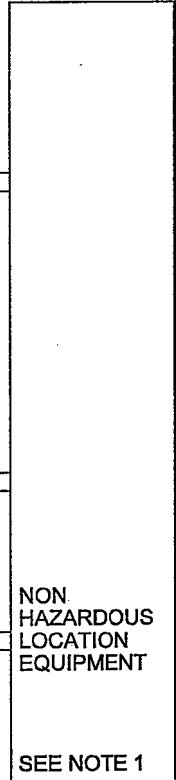
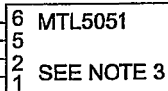
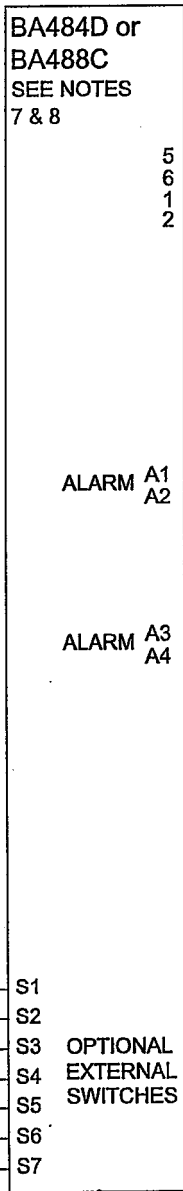

SEE NOTE 5

SEE NOTE 5

## Four Wire System

Iss.	Date	Modification	Ckd.	Appd.
1	01/03 2006	First release		
2	01/08	CFM requirements added.		

**BEKA associates**  
 England  
 Hitchin  
 company confidential, copyright reserved.

Title  
 FM Approvals Control Drawing for  
 Nonincendive BA484D & BA488C Serial Text Displays

Drawn RC	Checked	Scale NTS
Drawing No. Sheet 3		C1480-08



# SUB-MASTER

**Notes:**

1. The unclassified location equipment connected to the associated nonincendive field wiring apparatus must not use or generate more than 250V rms or 250V dc.
2. Nonincendive field wiring installations shall be in accordance with the National Electrical Code ANSI/NFPA 70. The Nonincendive Field Wiring concept allows interconnection of Nonincendive Field Wiring Apparatus with Associated Nonincendive Field Wiring Apparatus using any of the wiring methods permitted for unclassified locations. Installations in Canada shall be in accordance with the Canadian Electrical Code C22.2
3. FM & CSA Approved MTL5051 Serial-Data Communications Isolator installed in the unclassified location.
4. FM & CSA Approved MTL5025 Solenoid / Alarm Driver installed in the unclassified location.
5. Apparatus connected to the alarm contacts shall be FM, CFM or CSA Approved as Associated Nonincendive Field Wiring Apparatus and shall comply with the following requirements:

Voc	equal to or less than	Vmax
La	equal to or greater than	Lcable + Li
Ca	equal to or greater than	Ccable + Ci

6. Terminals S1 to S7 shall be connected to simple apparatus or volt free contacts of FM, CFM or CSA Approved Nonincendive Field Wiring Apparatus or FM, CFM or CSA Approved Associated Nonincendive Field Wiring Apparatus installed using Division 2 wiring methods.

7. To maintain IP66 protection between the BA488C and the mounting panel:

Four panel mounting clips should be used

Minimum panel thickness should be 2mm (0.08inches) Steel  
3mm (0.12inches) Aluminium

Outside panel finish should be smooth, free from particle inclusions, runs or build-up around cut-out.

Panel cut-out should be 66.2 x 136.0mm -0.0 +0.5  
(2.60 x 5.35 inches -0.00 +0.02)

Edges of panel cut-out should be deburred and clean

Each panel mounting clip should be tightened to between: 20 and 22cNm  
(1.77 to 1.95 inLb)

Iss.	Date	Modification	Ckd.	Appd.	 <p><b>BEKA associates</b> Hitchin England company confidential, copyright reserved.</p>
1	01.03 2006	First release			
2	01/08	CFM requirements added.			

Title		Drawn	Checked	Scale
FM Approvals Control Drawing for Nonincendive BA484D & BA488C Serial Text Displays		RC		NTS
		Drawing No. Sheet 4		CI480-08

# SUB-MASTER

8. When installed in a hazardous (classified) location the BA484D Serial Text Display shall be fitted with cable glands / conduit hubs selected from the following table.

Metallic glands and hubs must be grounded - see note 9.

Class	Permitted gland or conduit hub
Class I	Any metallic or plastic cable gland or conduit hub that provides the required environmental protection.
Class II and III	<p><b>Crouse - Hinds Myler hubs</b>                      SSTG-1   STG-1   STAG-1                      MHUB-1</p> <p><b>O-Z / Gedrey hub</b>                      CHMG-50DT</p> <p><b>REMKE hub</b>                      WH-1-G</p> <p><b>Killark Glands</b>                      CMCXAA050   MCR050   MCX050</p>

9. In addition to the supplied bonding plate, when 2 or 3 metallic glands or conduit hubs are fitted to a BA484D Fieldbus Display, all metallic glands or conduit hubs must be connected together and grounded.

10. **CAUTION:** The BA484D and BA488C Serial Text Display enclosures are manufactured from conductive plastic per Article 250 of the National Electrical Code the enclosures shall be grounded using the 'E' terminal on the terminal block.

11. Up to two BA484D and/or BA488C Serial Text Displays may be connected to one system.

12. Up to four BA484D and/or BA488C Serial Text Displays may be connected to one system.

Iss.	Date	Modification	Ckd.	Appd.
1	01/03 2006	First release		
2	01/08	CFM requirements added.		

**BEMA**  
Hitchin  
England  
**associates**  
company confidential, copyright reserved.

Title FM Approvals Control Drawing for Nonincendive BA484D & BA488C Serial Text Displays	Drawn RC	Checked	Scale NTS	Drawing No. Sheet 5	<b>CI480-08</b>
--	-------------	---------	--------------	------------------------	-----------------